

## RELAYS



GENERAL PURPOSE & POWER RELAYS



"Manufactured with Strict Quality and having undergone stringent Post-Production testing Procedures, these relays meet the requirement of our customers. The fact that these relays are manufactured by Salzer Electronics limited is your guarantee of quality and service."



## GENERAL PURPOSE MINIATURE Relays • 3/5 AMPS Resistive at 24V DC / 240VAC



**MSP (5 AMPS)**  
Plug-in type Enclosed version  
with LED indication 2 Poles



**MSP (5 AMPS)**  
Plug-in type Enclosed version  
with LED indication 3 Poles



**MSP (3 / 5 AMPS)**  
Plug-in type Enclosed version  
with LED indication 4 Poles

### SPECIFICATIONS

Contact Arrangement	2, 3, 4 changeover contacts
Contact Ratings	5 Amps Resistive for 2 / 3 / 4 pole Relays with LED display
Contact Resistance	50 m-ohms. Max (Initial)
Insulation Resistance	500 Meg. Ohms at 500 VDC
Ambient Temperature	-15° to +55° C
Contact Material	Agcdo
Electrical Life	100x10 <sup>3</sup> at rated voltage
Dielectric strength	As under
Between Contacts	1000V RMS
Between contact and coil	2000V RMS
Operate time at nominal voltage	< 20 m.secs
Release time at nominal voltage	< 10 m.secs
Max. Weight (in grams)	35g

### APPLICATIONS

Ideal for power &  
Sequence control

Instrumentation

Industrial Controls

Automation Systems

### ADVANTAGES

High Reliability

DIN RAIL mounting and  
LED Indication

### COIL DATA

Nominal Voltage DC & AC	Coil Resistance in Ohms + 10%		Pick-up Voltage (Max)	Release Voltage (Min)	
	DC	AC		DC	AC
06	41	13	4.8	0.6	1.8
12	165	53	9.6	1.2	3.6
18	330	-	14.4	1.8	5.4
24	660	210	19.2	2.4	7.2
48	2640	540	38.4	4.8	14.4
60	4200	-		6.0	18
110	13200	4400	88	11	33
220 V DC/240 AC	54000	19000	176/192	22	72

All values at 25° ambient

### ORDERING INFORMATION

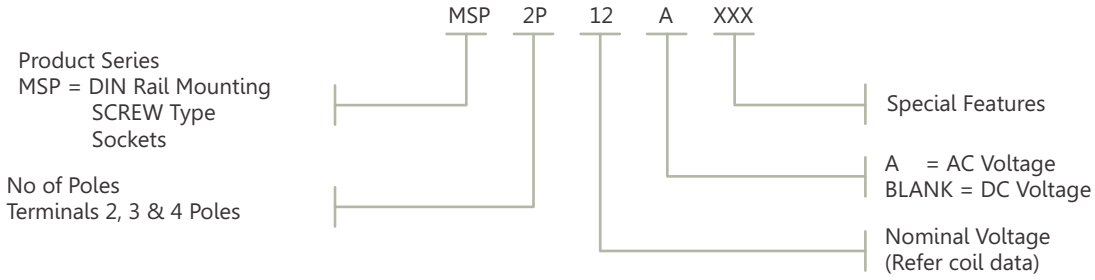

NOTE : PCB VERSION AVAILABLE ON REQUEST

### DIMENSIONS

### WIRING LAYOUT (BOTTOM VIEW)

MSP RELAY - 2P ASSEMBLY

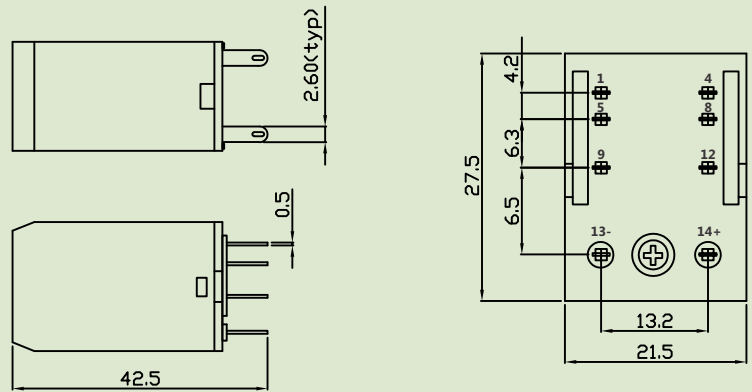

MSP RELAY - 3P ASSEMBLY

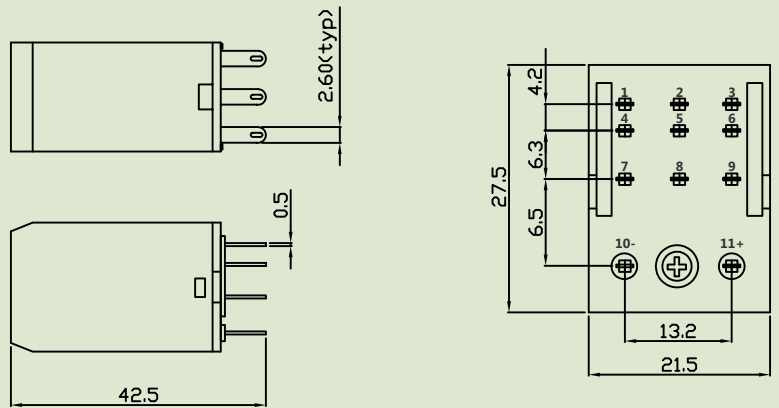

MSP RELAY - 4P ASSEMBLY

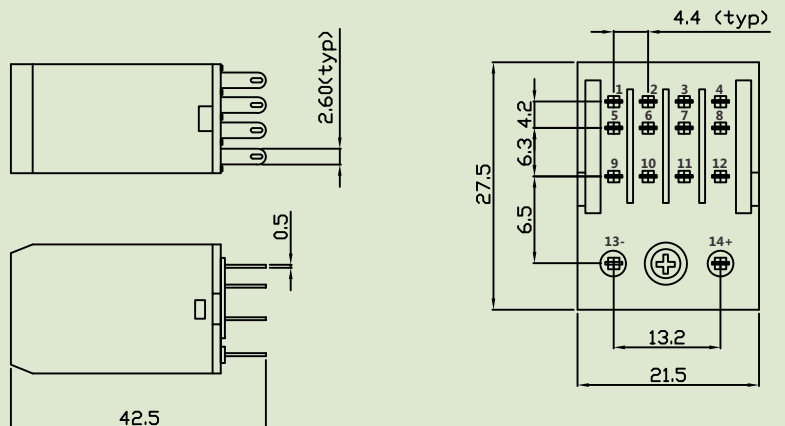

## GENERAL PURPOSE MINIATURE Relays • 15 AMPS, 10 AMPS resistive at 24V DC / 240VAC



**MSF (15 AMPS)**  
Plug-in type Enclosed version,  
PCB 1 Pole



**MSF (10 AMPS)**  
Plug-in type Enclosed version,  
PCB 2,3 & 4 Pole

## SPECIFICATIONS

Contact Arrangement	1, 2, 3, 4 changeover contacts
Contact Ratings	15 Amps Resistive for 1 pole 10 Amps for 2, 3 & 4 pole
Contact Resistance	100 m-ohms. Max (Initial)
Insulation Resistance	500 Meg. Ohms at 500 VDC
Ambient Temperature	-15° to +55° C
Contact Material	Agcdo
Electrical Life	100x10 <sup>3</sup> at rated voltage
Dielectric strength	As under
Between Contacts	1000V RMS
Between contact and coil	1500V RMS
Operate time at nominal voltage	< 15 m.secs
Release time at nominal voltage	< 10 m.secs
Max. Weight (in grams)	1, 2 Pole 35g, 3 Pole 50g, 4 Pole 65g

## APPLICATIONS

Ideal for power &  
Sequence control

Instrumentation

Industrial Controls

Automation Systems

## ADVANTAGES

High Reliability

DIN RAIL mounting and  
LED Indication

## COIL DATA

Nominal Voltage DC & AC	Coil Resistance in Ohms + 10%					Pick-up Voltage (Max)	Release Voltage (Min)	
	DC		AC				DC	AC
	1P/2P	3P/4P	1P/2P	3P	4P			
06	40	24	12	6	5	4.8	0.6	1.8
12	160	96	48	23	19	9.6	1.2	3.6
24	640	384	192	92	77	19.2	2.4	7.2
48	2560	1536	768	365	308	38.4	4.8	14.4
110	13400	8060	4035	1936	1615	88	11	33
220 V DC/240 AC	53800	32260	19200	9216	7680	176/192	22	72

All values at 25° ambient

**ORDERING INFORMATION**

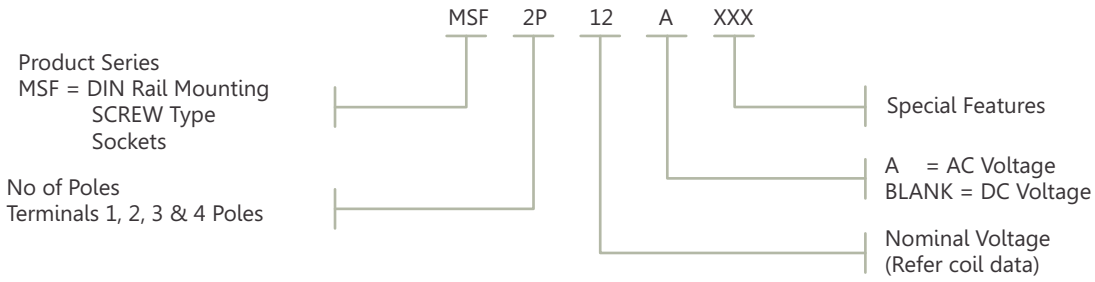

**NOTE : PCB VERSION AVAILABLE ON REQUEST**

MSF RELAY - 1 & 2P ASSEMBLY

**DIMENSIONS**

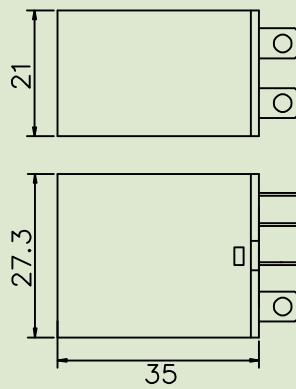

**WIRING LAYOUT (BOTTOM VIEW)**

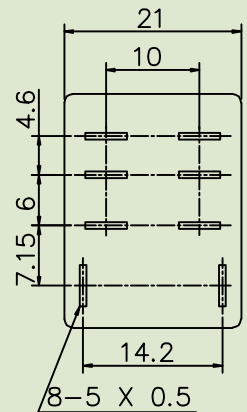

MSF RELAY - 3P ASSEMBLY

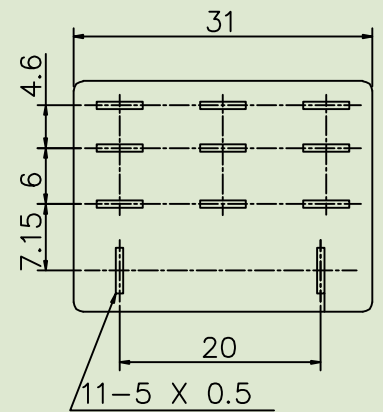
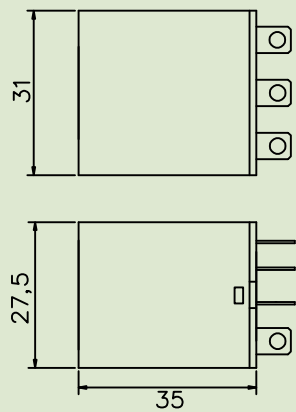

MSF RELAY - 4P ASSEMBLY

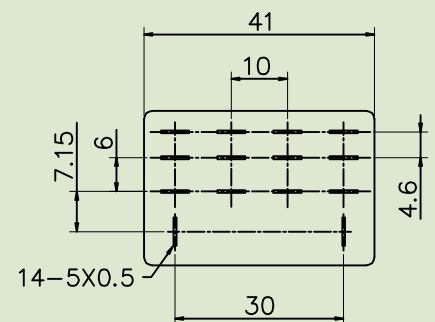
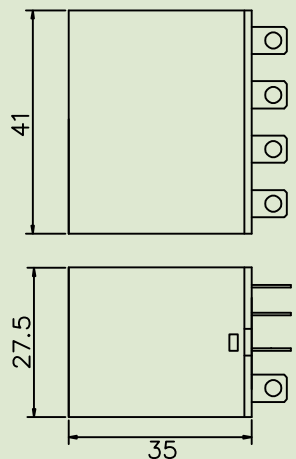

## MINIATURE Relays • 5/10 AMPS Plug-in Relays at 24V DC / 240VAC



**TYPE MKG/MKP (5/10 AMPS)**  
Plug-in type Enclosed version  
with LED indication



**MSC (5 AMPS)**  
Enclosed version Solder connection  
with LED indication 2 Poles



**TYPE PCB (5 AMPS)**  
Enclosed version  
for PCB

### SPECIFICATIONS

Contact Arrangement	1,2 or 3 changeover contacts
Contact Ratings	5 / 10 Amps Resistive at 24V DC / 240V AC
Contact Resistance	50 milli ohms Max ( Initial )
Insulation Resistance	500 Meg. Ohms at 500 VDC
Ambient Temperature	-15° to +55° C
Contact Material	Agcdo
Electrical Life	10 <sup>5</sup> Operations at rated voltage
Mechanical Life	10 <sup>7</sup> Operations
Dielectric strength	As under
Between Contacts	1500V RMS
Between contact and coil	2000V RMS
Operate time at nominal voltage	< 20 m.secs
Release time at nominal voltage	< 10 m.secs
Max. Weight (in grams)	MSC – 80g., MK – 95g., PCB – 80g
Coil Consumption	1.2 Watt / 2.4 VA

### APPLICATIONS

UPS  
Inverters  
Voltage stabilizers  
Process Control systems  
Instrumentation  
Industrial Controls  
Automation Systems  
Vending Machines  
Machine Tools  
Textile Machineries

### ADVANTAGES

High reliability  
Solder, Plug – in & PCB  
Version  
  
Meeting JSS 50711 Specs

### COIL DATA

Nominal Voltage DC & AC	Coil Resistance in Ohms + 10%		Pick-up Voltage (Max)	Release Voltage (Min)	
	DC	AC		DC	AC
06	30	07	4.8	0.6	1.8
12	1P, 2P-200 / 3P-150	30	9.6	1.2	3.6
18	390	55	14.4	1.8	5.4
24	2P, 3P-500 / 1P-600	110	19.2	2.4	7.2
48	2250	440	38.4	4.8	14.4
60	3400	-	48	6.0	18
110	10K	2400	88	11	33
220V DC/240V AC	34K	9700	176/192	22	72

All values at 25° ambient

NOTE: For 220V DC Coil Voltage 45K Resistor Can be offered on Request

**Product Series**

MSC = Solder Connections  
 MKG = Plug - in Connections  
 MKP = Plug - in Connection  
 PCB = Direct PCB typer

No of Poles  
 Terminals 1, 2, & 34 Poless

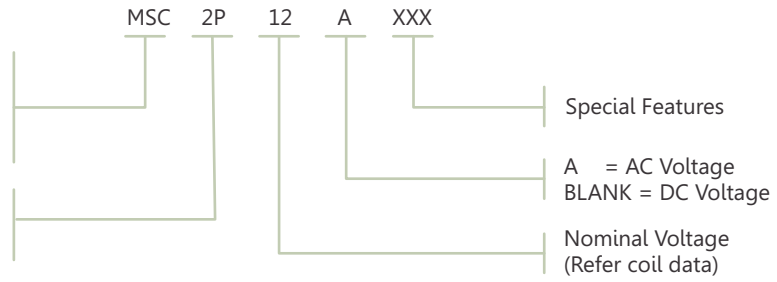

**WIRING LAYOUT FOR MK RELAYS**

(All Dimensions are in mm)

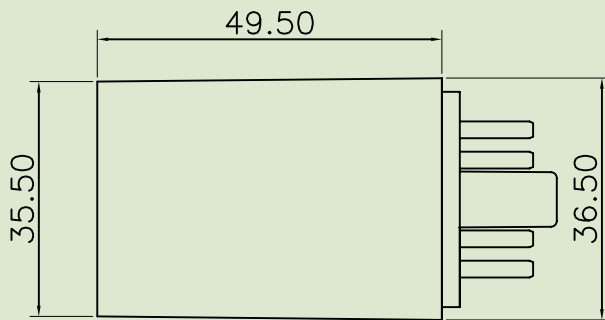

**WIRING LAYOUT**

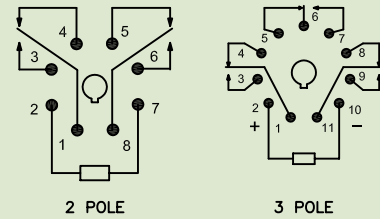

**WIRING LAYOUT FOR MSC RELAYS**

(All Dimensions are in mm)

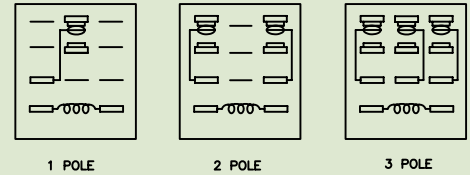
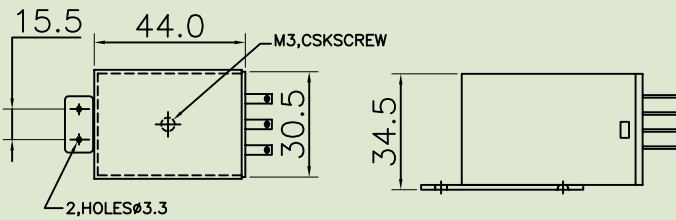

**WIRING LAYOUT FOR PCB RELAYS**

(All Dimensions are in mm)

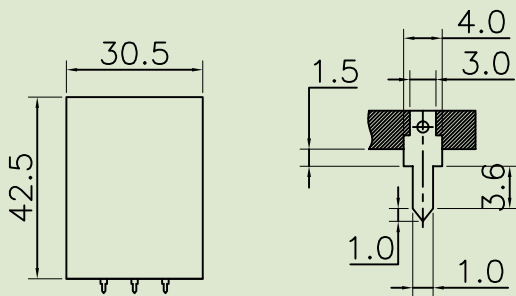

**WIRING LAYOUT**

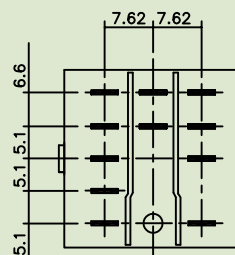
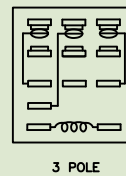

**MOUNTING DETAIL**

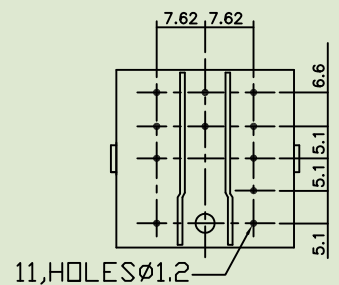



## PCB MOUNTING Relays 5 Amps / 10 Amps Resistive at 30VDC / 240VAC equivalent to G2R



**SSR (5 AMPS)**  
PCB Mounting Relay Enclosed version 2 Pole Contact  
Transparent Sealed Dust Proof Cover



**SSR (10 AMPS)**  
PCB Mounting Relay Enclosed version 1 Pole Contact  
Transparent Sealed Dust Proof Cover

### SPECIFICATIONS

Contact Arrangement	1 and 2 changeover contacts
Contact Ratings	10 Amps Resistive for SPDT & 5 Amps Resistive for DPDT contacts at 30VDC / 250 VAC.
Contact Resistance	≤50 milli ohms.
Insulation Resistance	500 Meg. Ohms at 500 VDC
Contact Material	Agcdo
Dielectric strength	Between open contacts : 1000 vrms Between coil to contact : 5000 vrms
Nominal Coil- voltage	6-48 VDC
Nominal Coil Power	DC : <0.53 W
Life (Electrical)	10 <sup>5</sup> Operations
(Mechanical)	1 X 10 <sup>7</sup> Operations
Weight	Approx : 17g
Operating Temp	-15° to +55° C
Mounting	PCB Mounting

### APPLICATIONS

Relay Modules  
PLCS  
Automation System  
Power and Sequence  
Control applications

### ADVANTAGES

A PCB Relay for a  
Variety of Purpose  
Automation System  
Universal Standard  
Specifications  
SPDT/DPDT Contacts  
available

### COIL DATA

Nominal Voltage DC & AC	Pick-up Voltage (Max)	Release Voltage (Min)
06	4.8	0.6
12	9.6	1.2
18	14.4	1.8
24	19.2	2.4
48	38.4	4.8

All values at 25° ambient

### ORDERING INFORMATION

**Product Series**

SSR = PCB Mounting  
 Relay Enclosed  
 Version Transparent  
 Sealed Dust Proof Cover

**No of Poles**

1 : 10 Amps  
 2 : 05 Amps

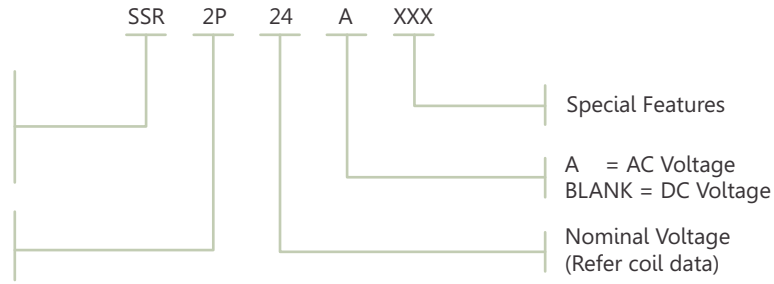

### DIMENSIONS

(All Dimensions are in mm)

SSR RELAY - 1P ASSEMBLY

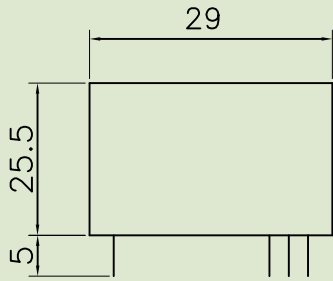

SSR RELAY - 2P ASSEMBLY

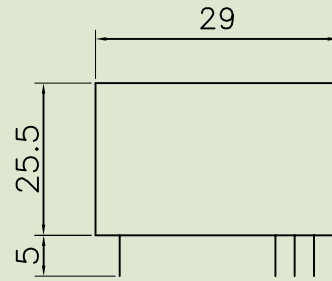

### MOUNTING DETAIL

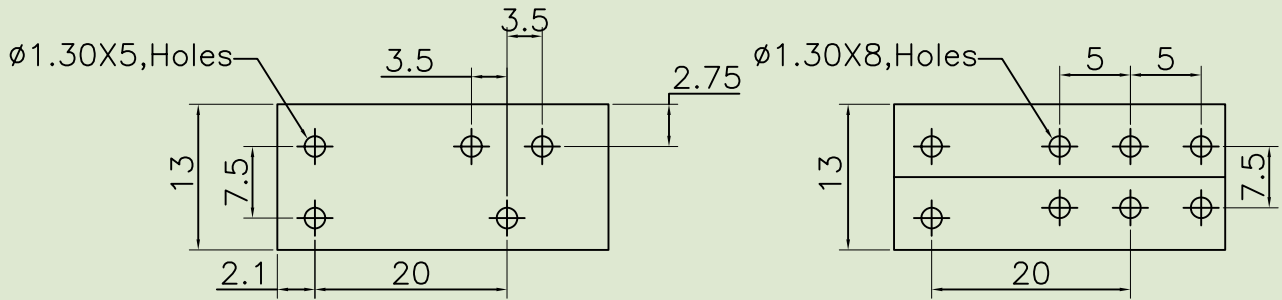

### WIRING LAYOUT

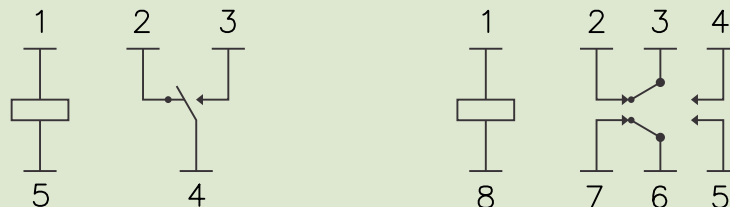

**MEDIUM POWER Relays •10 / 16 AMPS Resistive at 24V DC / 240V AC**

**TYPE HSC (10 Amps)**  
Enclosed version Solder connection



**TYPE HSR (16 Amps)**  
Enclosed version Solder connection

**SPECIFICATIONS**

Contact Arrangement	1,2 or 3 changeover contacts
Contact Ratings	10 / 16 Amps Resistive at 24V DC / 240V AC
Contact Resistance	50 milli ohms Max
Insulation Resistance	500 Meg. Ohms at 500 VDC
Ambient Temperature	-15° to +55° C
Contact Material	Agcdo
Electrical Life	10 <sup>5</sup> Operations at rated load
Mechanical Life	10 <sup>7</sup> Operations
Dielectric strength	As under
Between Contacts	1500V RMS
Between contact and coil	2000V RMS
Operate time at nominal voltage	< 25 m.secs
Release time at nominal voltage	< 15 m.secs
Max. Weight (in grams)	90g
Coil Consumption	1.2 watts / 2.4 VA

**APPLICATIONS**

Voltage Stabilizers  
UPS  
Control Panels  
Control Systems  
Industrial Controls  
Air Conditioners

**ADVANTAGES**

Elegant, Sturdy and light Weight  
Versatile Relay satisfying  
Low to Medium Power Sources

All values at 25° ambient

**COIL DATA**

Nominal Voltage DC & AC	Coil Resistance in Ohms + 10%		Pick-up Voltage (Max)	Release Voltage (Min)	
	DC	AC		DC	AC
06	30	7	4.8	0.6	1.8
12	120	30	9.6	1.2	3.6
18	270	-	14.4	1.8	5.4
24	480	110	19.2	2.4	7.2
48	2250	-	38.4	4.8	14.4
110	10K	2400	88	11	33
220V DC/240V AC	34K	9700	176 / 192	22	72

NOTE: For 220V DC Coil Voltage 45K Resistor Can be offered on Request

ORDERING INFORMATION

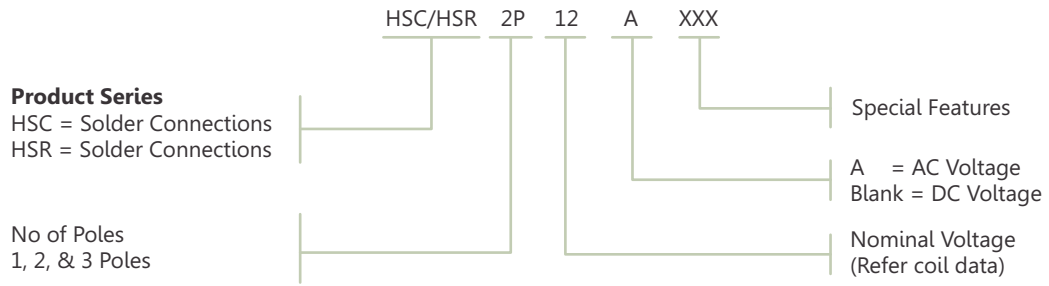

**Note : Plug - in Version with LED available in 10 Amps Rating**

DIMENSIONS FOR SERIES HSC/HSR RELAYS

(All Dimensions are in mm)

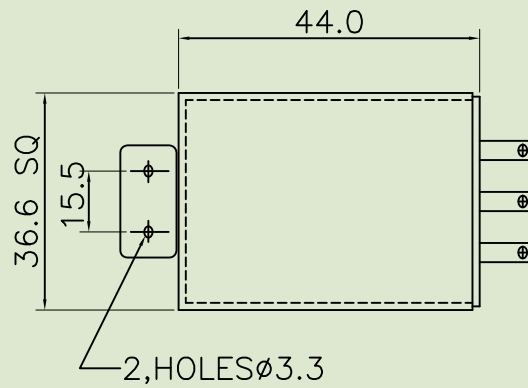

WIRING FOR SERIES HSC/HSR RELAYS

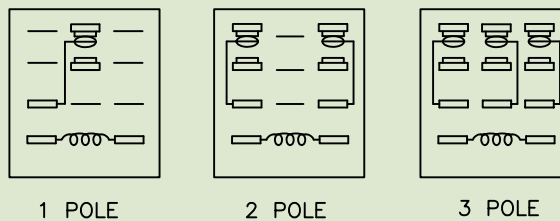

## PCB Mounting Relay 20 Amps (C/O) 30 Amps (N/O) Resistive at 30VDC / 240VAC



### STR PCB

Enclosed Version Sealed Dust Proof

## SPECIFICATIONS

Contact Arrangement	1 N/O Contact & 1 Changeover Contacts
Contact Ratings	30 Amps Resistive for 1 N/O 20 Amps Resistive for 1 C/O At 30VDC / 240VAC
Contact Resistance	≤100 milli ohms.
Insulation Resistance	1000 Meg. Ohms @ 500 VDC
Dielectric strength	Between open contacts : 1500 vrms Between coil to contact : 2500 vrms
Nominal Coil - voltage	12 & 24 VDC
Nominal Coil Power	DC : <0.93 W
Life (Electrical)	1 X 10 <sup>5</sup> Operations at rated voltage
(Mechanical)	1 X 10 <sup>7</sup> Operations
Weight	Approx : 33g
Operating Temp	-15° to +55° C
Mounting	PCB Mounting

## APPLICATIONS

Domestic application  
Automotive application  
Varied PCB  
low cost Applications

## ADVANTAGES

A power Relay for a  
Variety of Purpose  
Universal Standard  
Specifications Compact,  
sealed dust proof cover  
Small size high rating

## COIL DATA

Nominal Voltage DC & AC	Pick-up Voltage (Max)	Release Voltage (Min)
12	9.6	1.2
24	19.2	2.4

All values at 25° ambient

**ORDERING INFORMATION**

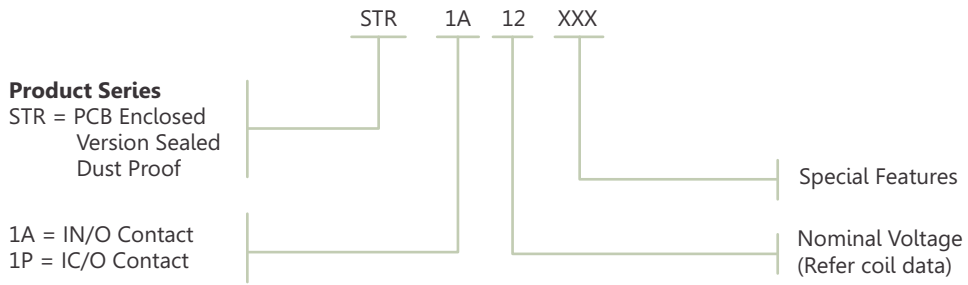

**Note : PCB Version available on Request**

**DIMENSIONS**

(All Dimensions are in mm)

STR RELAY

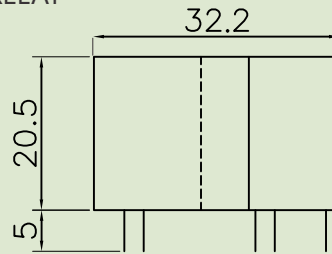

**MOUNTING DETAIL**

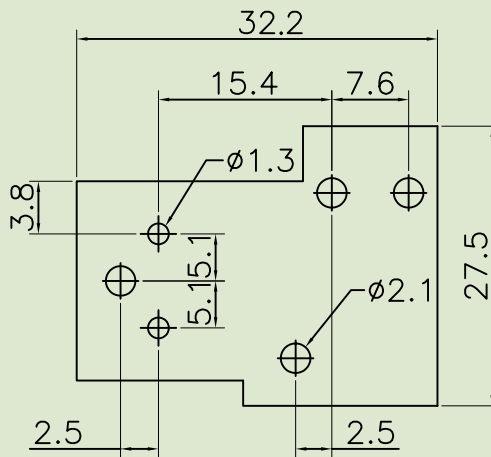

**WIRING LAYOUT**

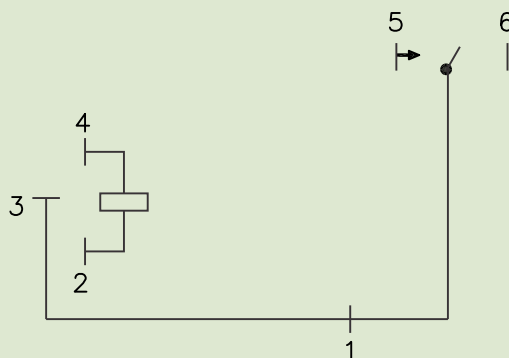

### SPECIFICATIONS

#### 25 Amp, SPDT & DPDT, AC & DC Relays

Contact Arrangement	1 Changeover contacts (Terminal Screw Type) 1&2 Changeover contacts (Solderable type)
Contact Materials	Silver cadmium oxide (or) gold flash coat (Optional)
Contact Ratings	25 Amps Resistive at 28 VDC / 250 VA
Contact Resistance	15 m-Ohms.max
Insulation Resistance	500 meg.Ohms at 500 VDC
Ambient Temperature	-15° to +55°C
Nominal Coil Power	1.2 Watts
Electrical Life	5x10 <sup>4</sup> operations at rated load
Mechanical Life	10 <sup>7</sup> operation
Dielectrical strength	As under
Between open contacts	1500 VRMS
Pole to Pole	2000 VRMS
Body to contact and coil	2000 VRMS
Operate time at nominal voltage	< 25 msecs
Release time at nominal voltage	< 15 msecs

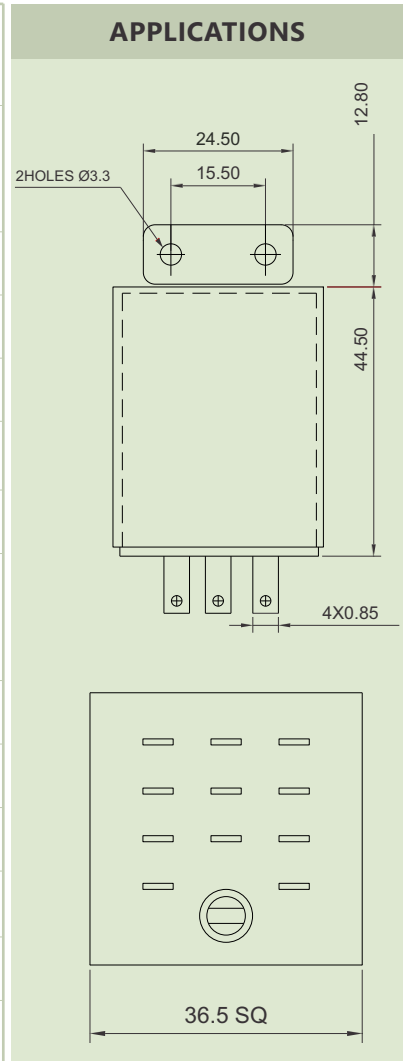

### COIL DATA

Nominal Voltage DC & AC	Coil Resistance in Ohms + 10%		Pick-up Voltage (Max)	Release Voltage (Min)	
	DC	AC		DC	AC
06	30	7	4.8	0.6	1.8
12	120	30	9.6	1.2	3.6
24	480	110	19.2	2.4	7.2
48	2250	440	38.4	4.8	14.2
110	10K	2.4	88	11	33
220/240 AC	34K	9.7K	176 / 192	22	72

NOTE: For 220V DC Coil Voltage 45K Resistor Can be offered on Request

### WIRING LAYOUT FOR PRC25

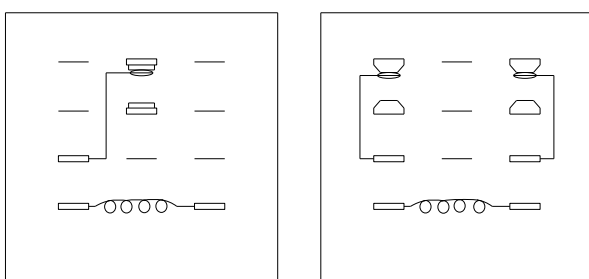

1 POLE

2 POLE

### ORDERING INFORMATIONS

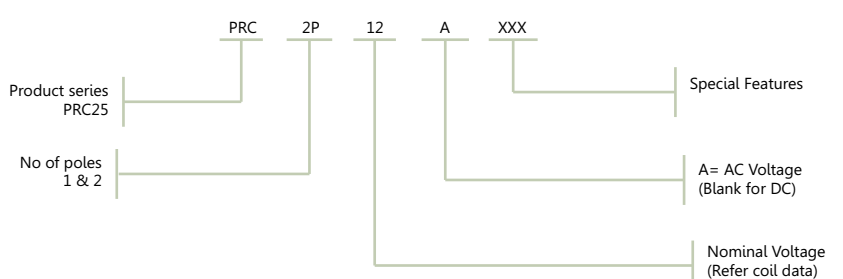

## POWER Relays •30/40/60/80/100 AMPS Resistive AT 28V DC / 240V AC



**TYPE PRC 30**  
(30 AMPS)

Enclosed Version Solder Terminal



**TYPE PRC 40 & 60**  
(40 & 60 AMPS)

Enclosed Version Screw Terminal



**TYPE PRC 80**  
(80 AMPS)

Enclosed Version Screw Terminal

### APPLICATIONS

Inverter  
UPS  
Voltage stabilizer  
Automation Equipment  
Vending machines

### ADVANTAGES

High Reliability  
Solder & Screw Terminal

### SPECIFICATIONS

S.No	Tech Data	PRC-30-1/2/3P	PRC-40-1P	PRC-60-1P	PRC-801p/100-1P
1	Size (mm)	42 X 51 X 67	78 X 48 X 50	78 X 48 X 50	83 X 48 X 72
2	Contact capacity	AC 30A/240V DC 30A/28V	AC 40A/240V DC 40A/28V	AC 60A/240V DC 60A/28V	AC 80A / 100A / 240V DC 80A / 100A / 28V
3	Contact Resistance	50 Initial	50 Initial	50 Initial	50 Initial
4	Contact configuration	1P / 2P / 3P	1P	1P	1P
5	Insulation resistance (mohms)	500 at 500V DC	500 at 500V DC	500 at 500V DC	500 at 500V DC
6	Dielectric Strength				
	Bet. Open Contacts	1500 VAC	1500 VAC	1500 VAC	1500 VAC
	Bet. Coil to Contact	2500 VAC	2500 VAC	2500 VAC	2500 VAC
7	Coil nominal Voltage	AC 240V / 24V DC 12V / 24V	AC 240V / 24V DC 12V / 24V	AC 240V / 24V DC 12V / 24V	AC 240V / 24V DC 12V / 24V
8	Coil nominal power	DC 2W	DC 2W	DC 2.5W	<3.5W
9	Electrical life - Operations	10 <sup>5</sup>	10 <sup>5</sup>	0.5 X 10 <sup>5</sup>	0.1 X 10 <sup>5</sup>
10	Mechanical life - Operations	10 <sup>7</sup>	10 <sup>7</sup>	10 <sup>7</sup>	10 <sup>7</sup>
11	Weight (g)	105	135	135	225



**ORDERING INFORMATION**

**Product Series**

PRC = Solder Screw Terminals

No of Poles  
1, 2, 3 Poles

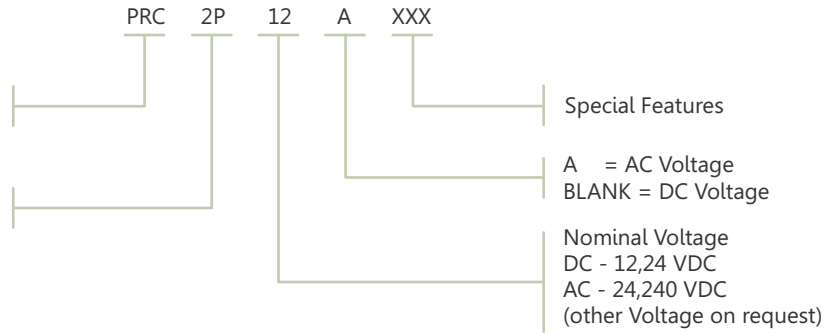

**POWER RELAY 30AMPS  
OVERALL DIMENSIONS**

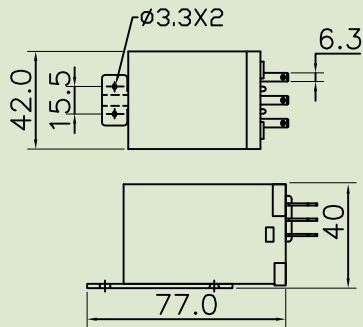

**WIRING LAYOUT (BOTTOM VIEW)**

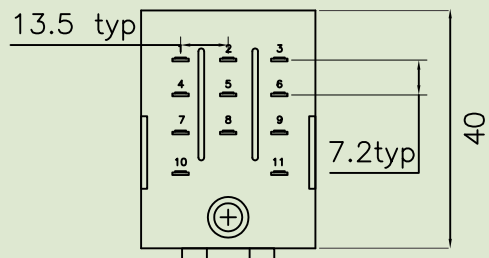

**POWER RELAY 40AMPS  
OVERALL DIMENSIONS**

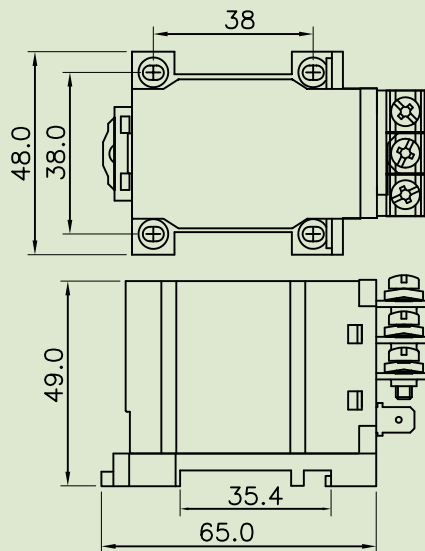

40AMPS

60AMPS

8.80(TYP)

10.30

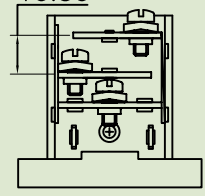
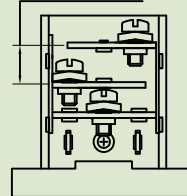

**POWER RELAY 80/100AMPS  
OVERALL DIMENSIONS**

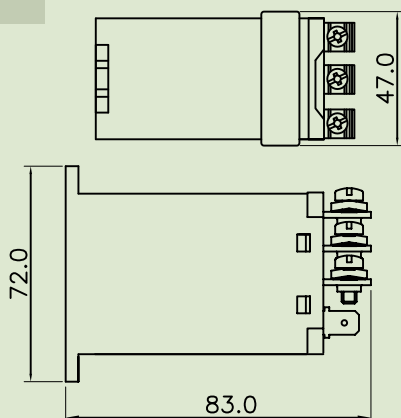

**WIRING LAYOUT (BOTTOM VIEW)**

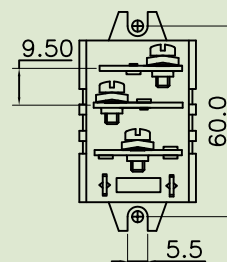

## Automotive Power Relays 70 Amps Resistive at 14V DC



### SPECIFICATIONS

Contact Arrangement	1 N/0
Contact Ratings	50A, 70A at 14V DC
Contact Resistance	$\leq 30$ mohms.
Insulation Resistance	$\leq 100$ Mohms at 500 VDC
Dielectric strength	Between open contacts : 50Hz, 1000V
	Between coil to contact : 50Hz, 500V
Nominal Coil- voltage	12 – 24 VDC
Nominal Coil Power	1.6 watt
Life (Electrical)	1 X 10 <sup>5</sup> Operations
	(Mechanical)
Weight	Approx : 37g
Max Switching Power	980 Watts
Max Switching Voltage	75V Dc

### APPLICATIONS

Domestic application  
Automotive application  
Varied PCB low cost  
Applications

### ADVANTAGES

A power Relay for a  
Variety of Purpose  
  
Universal Standard  
  
Specifications Compact,  
sealed dust proof cover  
  
Small size high rating



## **Salzer Electronics Limited**

Registered & Corporate Office: Samichettipalayam, Coimbatore - 641 047, India.

Phone: +91 422 - 2692531, 4233600 Fax: +91 422 - 2692170

e-mail: [sales@salzergroup.com](mailto:sales@salzergroup.com) | [salzer@salzergroup.com](mailto:salzer@salzergroup.com)

[www.salzergroup.com](http://www.salzergroup.com)