



C-line

Onload Changeover Switch-Disconnectors

About us

Larsen & Toubro infuses engineering with imagination. The Company offers a wide range of advanced solutions in the field of Engineering, Construction, Electrical & Automation, Machinery and Information Technology.

L&T Switchgear, a part of the Electrical & Automation business, is India's largest manufacturer of low voltage switchgear, with the scale, sophistication and range to meet global benchmarks. With over five decades of experience in this field, the Company today enjoys a leadership position in the Indian market with a growing international presence.

It offers a complete range of products including powergear, controlgear, industrial automation, building electricals & automation, reactive power management, energy meters, and protective relays. These products conform to Indian and International Standards.



Switchgear Factory, Mumbai



Switchgear Factory, Ahmednagar

Changeover Switches

C-Line offers you a unique series of changeover Switches combining compactness with high performance, thus, making C-line a state-of-the-art product in changeover technology.

The C-line range covers ratings from 63 A to 1000 A in 5 frame size. These changeover are available in open execution SS enclosures and fused version (type DIN / BS fuses).



Basic function of Changeover Switches

Onload Changeover S-D consists of two separate sets of terminals for connecting two incoming supplies and the output terminals need to be joined together to supply the common load. Thus, changeover ensures continuity of supply to the load by alternating between normal and alternate supply.

Manual Onload Changeover S-D has 3 stable positions as defined below

POSITION I

Switch is in ON position with normal supply available at the outgoing terminals.

POSITION 0

Switch is in OFF position and both (normal and alternate supplies) are isolated from the outgoing terminals.

POSITION II

Switch is in ON position with alternate supply available at the outgoing terminals.

Product Features

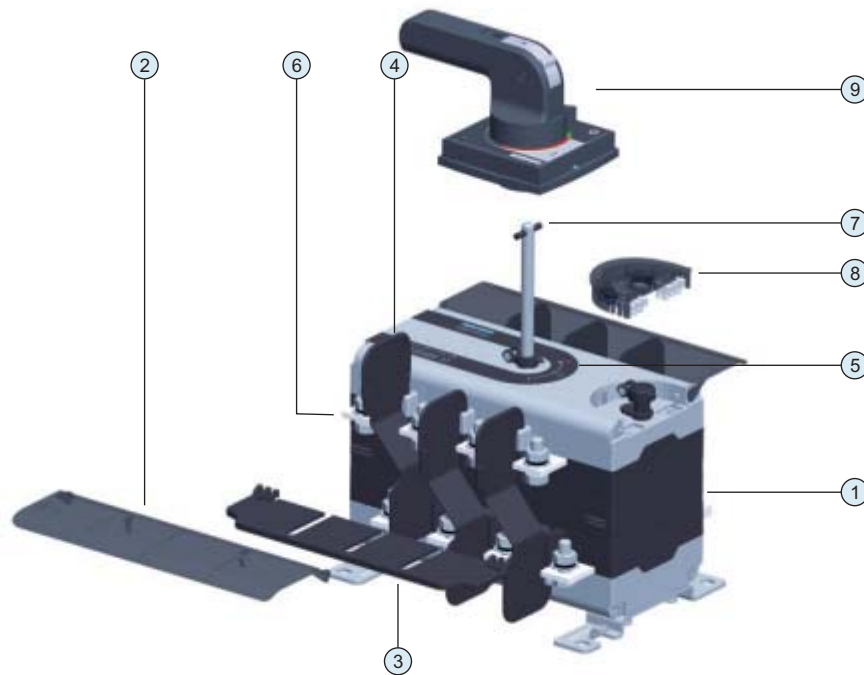

1 Mechanism

A single, compact and modular mechanism cassette operates two Switch-Disconnectors and provides mechanical interlocking between them. The use of patented, self interlocked and dual dead center mechanism in C-line range provides higher reliability for changeover function.

2 Terminal shroud

These shrouds provide complete touch proof design and prevent accidental touching of live terminals. They are click fit type. Due to hinge type design terminal, shrouds can be turned by 90 degree, hence terminals can be inspected without removing these shrouds.

3 Source separator

Source separator is used to isolate two incoming supplies and to eliminate possibility of flash over between two supplies due to accidental falling of external objects.

4 Inter-phase barriers

Inter-phase barriers are provided for additional safety to eliminate possibility of inter-phase short-circuit.

5 Positive ON / OFF indication of S-Ds

Changeover S-D indicates true position of contacts.



6 Staggered terminals

The C-line Changeover S-Ds are designed to have staggered terminal arrangement for top and bottom S-Ds. It provides clear access to all terminals from the front, ensuring ease of termination. All terminal joints can be easily inspected without the need of removing termination of top S-D.



7 Spacious SS enclosure

The changeover is SS enclosure consists of gland box by default.

8 Interchangeable dual shaft position with site convertibility

Patented dual dead center mechanism enables the user to opt between central or side shaft positions for operating handle. This can be easily converted on site as required (125 A to 1000 A).

9 Auxiliary contact kit

It consists of two changeover contacts one for each S-D. This kit is pre-wired with terminal blocks and can be fitted at the site without increasing overall dimension.

10 Handle

The Changeover Switch has a unique flip-able operating handle for ratings 400 Amp and above which enables user to operate the switch with two hands. The handle also offers the following features:

- Provision for providing 3 padlocks in OFF Position
- Defeat feature in both ON states and auto restoration of panel door
- IP54 with all varied depth type operating handle



One hand type handle
up to 315 A rating



Two hand type for above
400 A rating



Changeover unit pad
lockable in OFF state by 3 pad locks

Superior Performance

Highest short-time ratings

Contact system is of double break, knife type having self wiping action with electrodynamic compensation. This ensures reliable performance during normal as well as most severe short circuit fault conditions, offering higher short-time withstand rating.

Highest life

C-line switch offers highest electrical and mechanical life in compact frame sizes. The electrical and mechanical life are two times the requirement of the standard.

Higher neutral ratings

Four pole configuration is with 100% neutral rating. 150% & 200% neutral ratings are also available.

Total flexibility of connection

Factory fitted external shorting links can be easily removed and fitted on the other side as required at site. This gives more flexibility at the time of installation.

Maximum termination capacity

The C-line range provides generous terminal capacity in its compact size facilitating aluminium termination.

Higher ground clearance

Higher ground clearance between terminals and mounting base plate ensures adequate clearance even after connecting cables. This eliminates the possibility of phase to ground flashover.

Total safety

C-line Changeover Switch provides complete safety by providing terminal shrouds, source separator and inter-phase barriers.

Product Range

Onload Changeover S-Ds are available from 63 A to 1000 A. The range is covered through 5 frames as shown below.

Frame No.	Ratings (A)		
1	63	100	
2	125	160	200
3	250	315	
4	400	630	
5	630	800	1000

Versions

C-line Changeovers are available with and without fuses, suitable for open execution and in sheet steel (SS) enclosures.

Changeover S-D suitable for open execution

Changeover S-D, which can be commissioned in panels, are of open execution type and provide IP30 protection from front.

Onload changeover S-D in SS enclosures

Onload Changeover S-Ds are available in sheet steel enclosure with adequate space for cable terminations so that additional cable entry boxes are not required. Cable gland plates are also provided with the switch. Enclosure provides IP54 protection.

Changeover S-D suitable for HRC fuses

The Changeover S-Ds for open execution can be easily converted to fused version at site by using fuse conversion kit. It provides the benefits of overload and short circuit protection through the fastest switching device-fuse, and is suitable for knife type (DIN) and bolted type (BS) fuse links. Use of L&T HN fuse links reduces watt loss.

Technical Specifications



		Frame 1		Frame 2			Frame 3		Frame 4		Frame 5				
Rating (A)	Unit	63 A	100 A	125 A	160 A	200 A	250 A	315 A	400 A	630 A	630 A	800 A	1000 A		
Reference Standards		IEC 60947-3, EN 60947-3, IS 13947 (Part 3)													
Type designation		CO1-63	CO1-100	CO2-125	CO2-160	CO2-200	CO3-250	CO3-315	CO4-400	CO4-630	CO5-630	CO5-800	CO5-1000		
No. of Poles		4 Pole	4 Pole	4 Pole	4 Pole	4 Pole	4 Pole	4 Pole	4 Pole	4 Pole	4 Pole	4 Pole	4 Pole		
Rated operational voltage (U_n)		(V)	415	415	415	415	415	415	415	415	415	415	415		
Rated frequency		(Hz)	50 / 60	50 / 60	50 / 60	50 / 60	50 / 60	50 / 60	50 / 60	50 / 60	50 / 60	50 / 60	50 / 60		
Rated impulse withstand voltage (U_{imp})		(kV)	8	8	12	12	12	12	12	12	12	12	12		
Pollution degree			3	3	3	3	3	3	3	3	3	3	3		
Conventional free air thermal current, I_n at 40°C		(A)	63	100	125	160	200	250	315	400	630	630	800	1000	
Conventional enclosed thermal current, I_{ne} at 40°C		(A)	63	100	125	160	200	250	315	400	630	630	800	1000	
Rated operational current, I_n AC-21A / AC-22A / AC-23A		(A)	63	100	125	160	200	250	315	400	630	630	800	1000	
Rated operational power for AC-23A*		(kW)	37	50	65	85	100	132	160	225	315	315	400	450	
Rated breaking capacity for AC-23A		(A)	504	800	1000	1280	1600	2000	2520	3200	5040	5040	6400	8000	
Rated making capacity for AC-23A		(A)	630	1000	1250	1600	2000	2500	3150	4000	6300	6300	8000	10000	
Short time withstand, I_{sw}	1 sec	(kA rms)	4	5	8	8	10	16	18	22	26	35	50	50	
	0.2 sec	(kA rms)	7	10	18	18	18	28	28	35	35	70	85	85	
Short-circuit making capacity, I_{sm}		(kA peak)	5.9	7.7	14	14	17	32	36	46	55	73.5	105	105	
Endurance (category A)	Mechanical	(O-I-O-II-O cycle)	10000	10000	16000	16000	16000	16000	16000	10000	10000	10000	10000	10000	
	Electrical	(O-I-O-II-O cycle)	1500	1500	2000	2000	2000	2000	2000	2000	2000	2000	1000	1000	
Type and size of fuse	DIN/Cylin*		14x51*	NA	00	00	00	1	1	2	NA	3	3	NA	
	BS		NA	NA	A4	B2	B2	B3	B3	B4		C2	C3		
Rated fused short-circuit current at 415 V, 50/60 Hz	DIN	(kA rms)	80	NA	100	100	100	100	100	100		100	100		100
	BS	(kA rms)	NA	NA	80	80	80	80	80	80		80	80		80
Termination Capacity															
Maximum Al. cable with lug		(sq mm)	25	25	95	95	150	185	240	2 x 300	2 x 300	2 x 400	2 x 400	2 x 400	
Maximum link width		(mm)	16	16	30	30	30	40	40	50	50	60	60	60	
Maximum link thickness		(mm)	2	2.5	5	5	6	8	8	8	2 x 8	2 x 10	2 x 10	2 x 10	
Termination tightening torque		(N-m)	4.5	4.5	10	10	20	20	20	27	27	35	35	35	
Operating torque center / side operating		(N-m)	4.5	4.5	10 / 13	10 / 13	10 / 13	20 / 25	20 / 25	28 / 32	28 / 32	30 / 40	30 / 40	30 / 40	
Weight (without accessories)		(Kg)	2	2.5	4	4	4.5	6.5	7	14	14.5	20	22	22	

*These values are for 4 pole squirrel cage induction motors and are provided only for guidance and may vary as per the motor manufacturer.

Accessories

Fuse conversion kit

Fuse Conversion Kit is available with knife type (DIN) and bolted type (BS) fuse links. Changeover Switch can be converted to fused version at site.



Fuse Conversion Kit Type BS

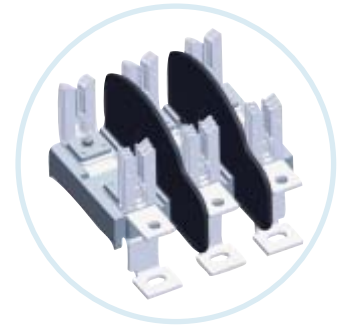

Fuse Conversion Kit Type DIN

Castell lock

Accessory to lock the Changeover Switch in OFF state and using this can have interlocking schemes with MCCB/ACB.



Ordering Information

Onload changeover switches

Description	125 A	160 A	200 A	250 A	315 A	400 A	630 A	630 A	800 A	1000 A
Onload Changeover Switch-Disconnecter	CO212500000	CO216000000	CO220000000	CO325000000	CO331500000	CO440000000	CO463000000	CO563000000	CO580000000	CO510000000
Onload Changeover in SS enclosure	CO212500S00	CO216000S00	CO220000S00	CO325000S00	CO331500S00	CO440000S00	CO463000S00	CO563000S00	CO580000S00	CO510000S00

Spares & accessories

Description	125 A	160 A	200 A	250 A	315 A	400 A	630 A	630 A	800 A	1000 A
Fuse Conversion Kit for DIN type Fuses	CX2125000D0	CX2160000D0	CX2200000D0	CX3250000D0	CX3315000D0	CX4400000D0	NA	CX5630000D0	CX5800000D0	NA
Fuse Conversion Kit for BS type Fuses	CX2125000B0	CX2160000B0	CX220000000	CX3250000B0	CX3315000B0	CX4400000B0		CX5630000B0	CX5800000B0	
Operating Handle	CX300010000					CX400010000		CX500010000		
Auxiliary Contact Kit	CX200020000		CX300020000			CX400020000		CX500020000		
Castell Lock	CX500040000									
External Shorting link	CX216050000		CX220500000	CX300050000		CX400050000		CX563050000	CX580050000	CX510050000
Terminal Shroud	CX200060000			CX300060000		CX400060000		CX500060000		
Inter-phase Barriers	CX200070000			CX300070000		CX400070000		CX500070000		
Phase Barrier for Fused version	CX200080000			CX300080000		CX400080000	NA	CX500080000		NA
Source Separator	CX200090000			CX300090000		CX400090000		CX500090000		

Overall Dimensions CO1 - 63 / 100

Open Execution - with Direct Handle

Rating	Termination Bolt
CO1-63/100 A	M6

Rating	Cat. No.	A
CO1-63 A	CO106300OOD	2
CO1-100 A	CO110000OOD	2.5

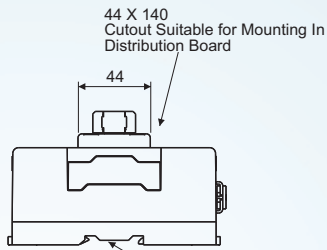

Provision of Mounting on Th35- 7.5 Rail As Per Is 11039

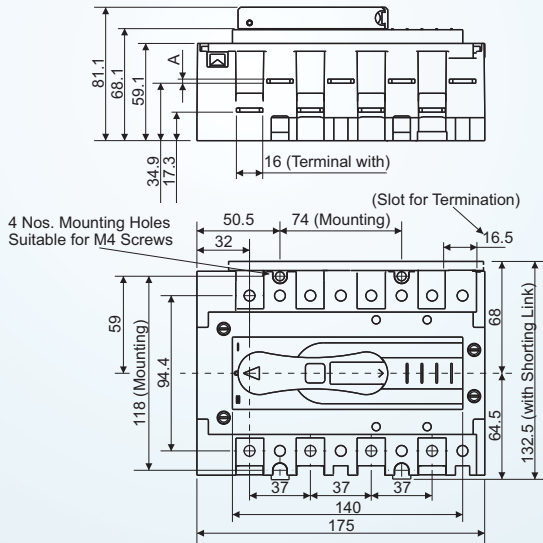

In SS Enclosure

Rating	Termination Bolt
CO1-63/100 A	M6

Rating	Cat. No.
CO1-63 A	CO106300SOO
CO1-100 A	CO110000SOO

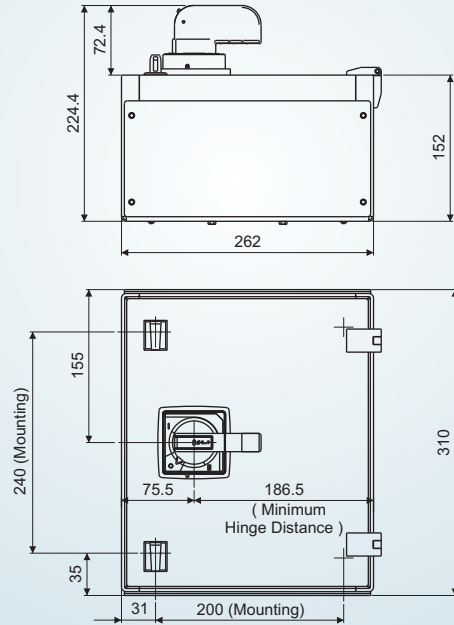

Open Execution - with Extended Handle

Rating	Termination Bolt
CO1-63/100 A	M6

Rating	Cat. No.	A
CO1-63 A	CO106300OOO	2
CO1-100 A	CO110000OOO	2.5

* Assemble bushes for higher ground clearance.

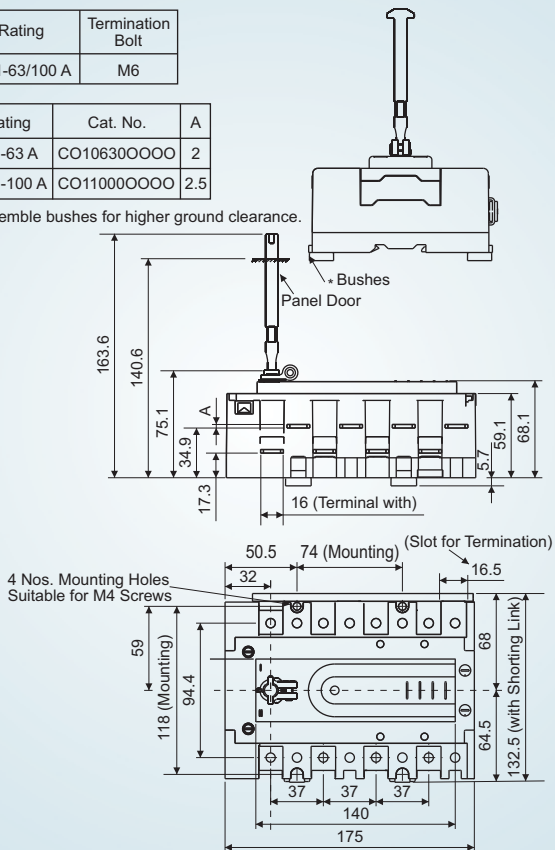

Cylindrical Type Fuse Link

Rating	Termination Bolt
CO1-63 A	M6

Rating	Cat. No.	Size Of Fuse
CO1-63 A	CO106300OCO	14 X 51

*Assemble bushes for higher ground clearance

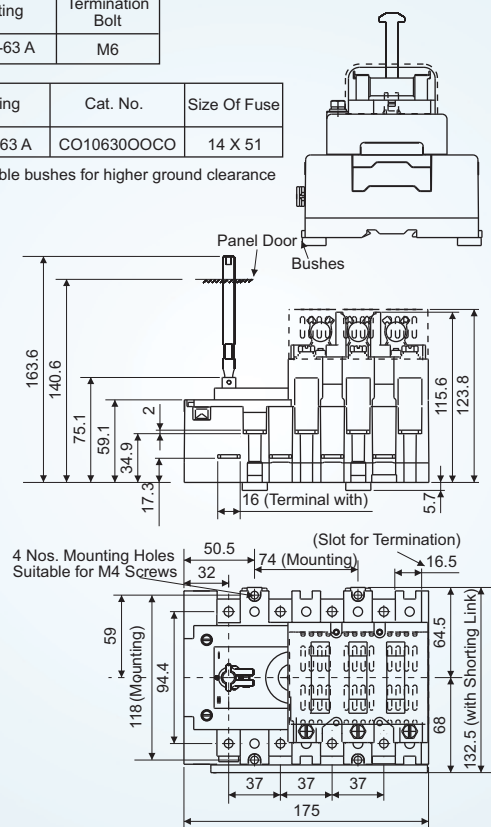

Overall Dimensions CO2 - 125 / 160 / 200

Open Execution

Rating	A	B	C	D	E
CO2-125	22	3	138	121	220
CO2-160	22	3	138	121	203
CO2-200	26	5	150	121	204

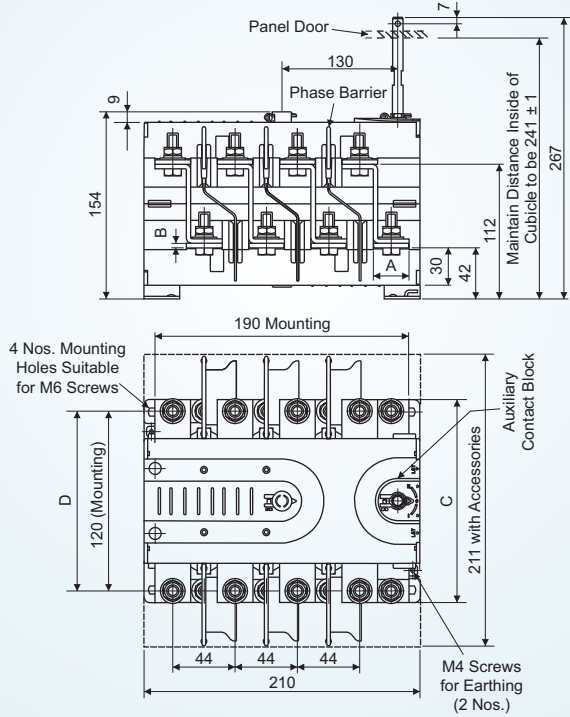

In SS Enclosure

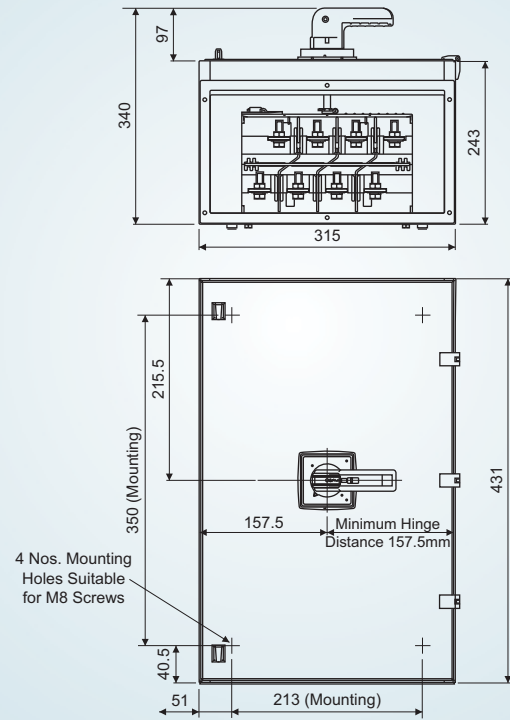

For DIN Type Fuses

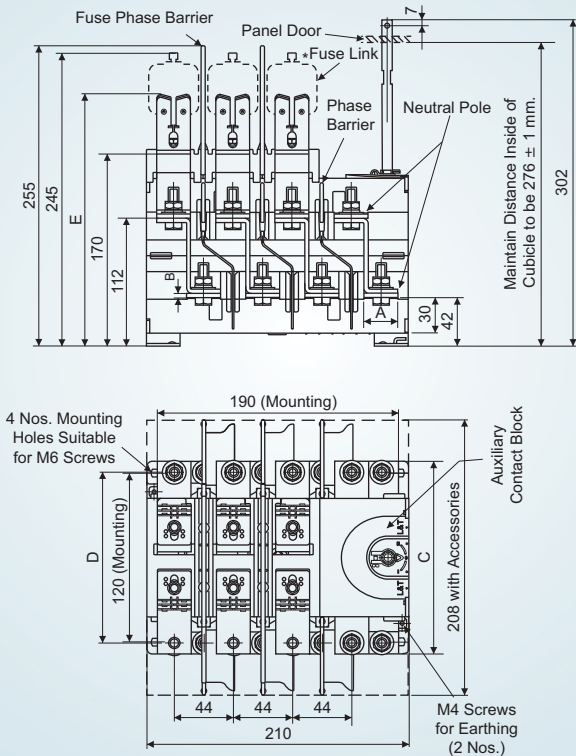

For BS Type Fuses

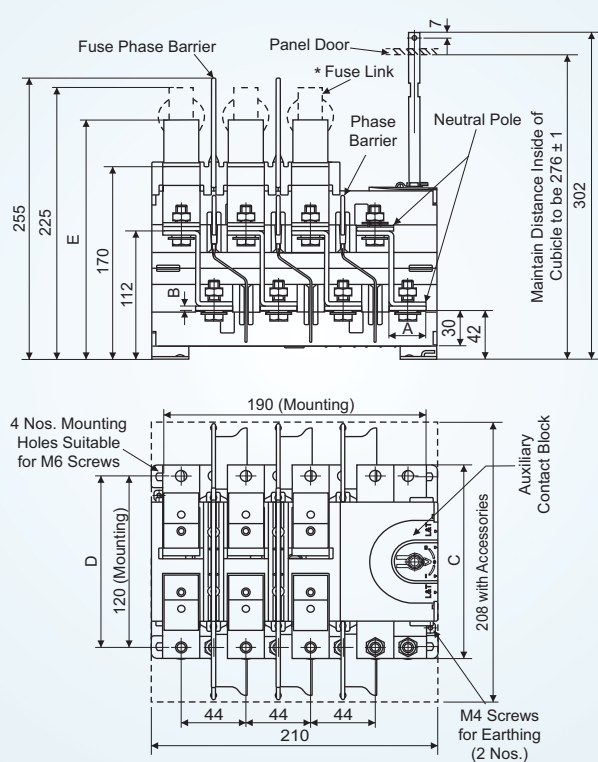

Overall Dimensions CO3 - 250 / 315

Open Execution

Rating	A	B	C	D
CO3-250	29	4.5	182	156
CO3-315	35	5	198	164

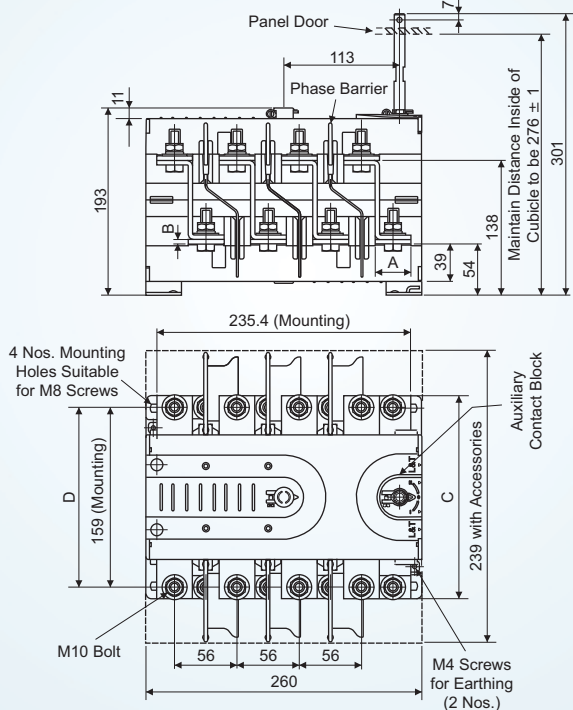

In SS Enclosure

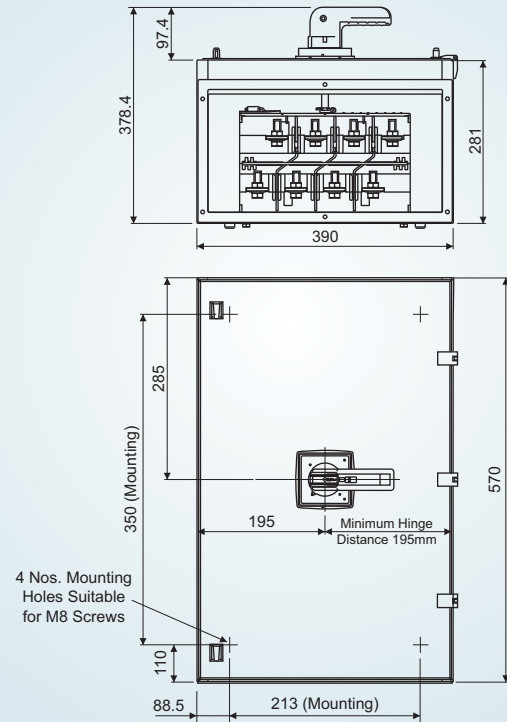

For DIN Type Fuses

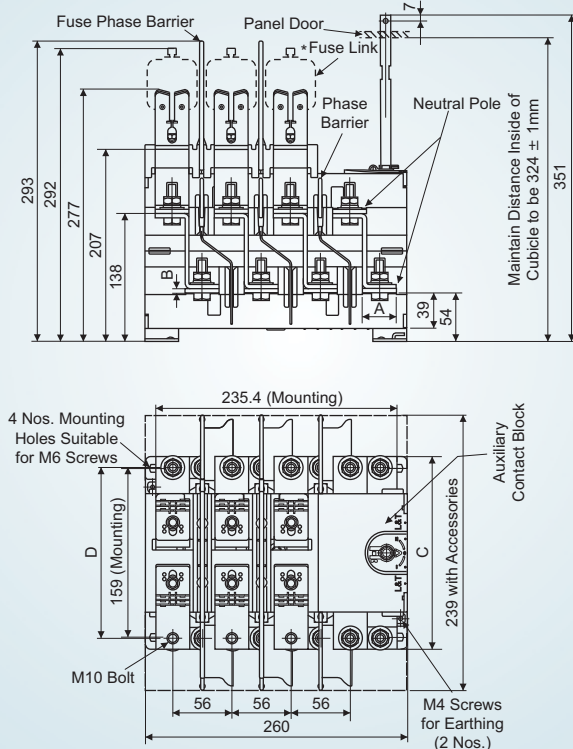

For BS Type Fuses

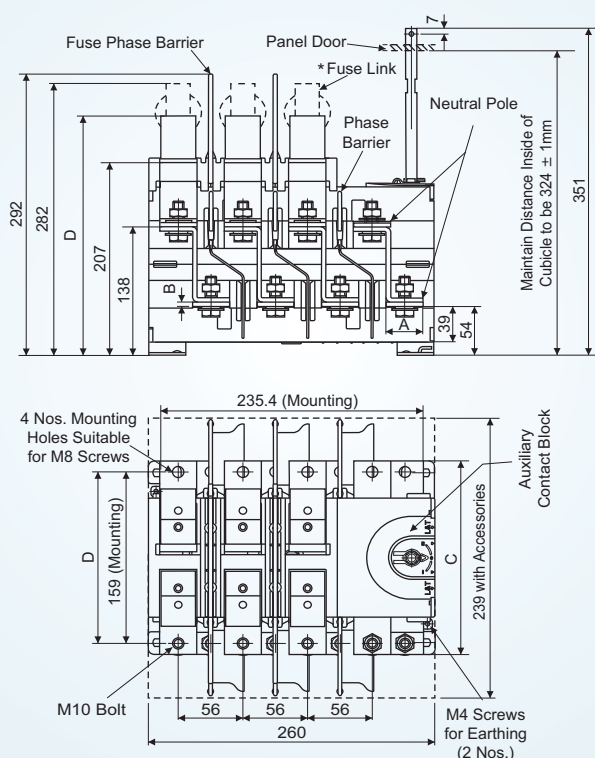

Overall Dimensions CO4 - 400 / 630

Open Execution

Rating	A
CO4-400	5
CO4-630	6

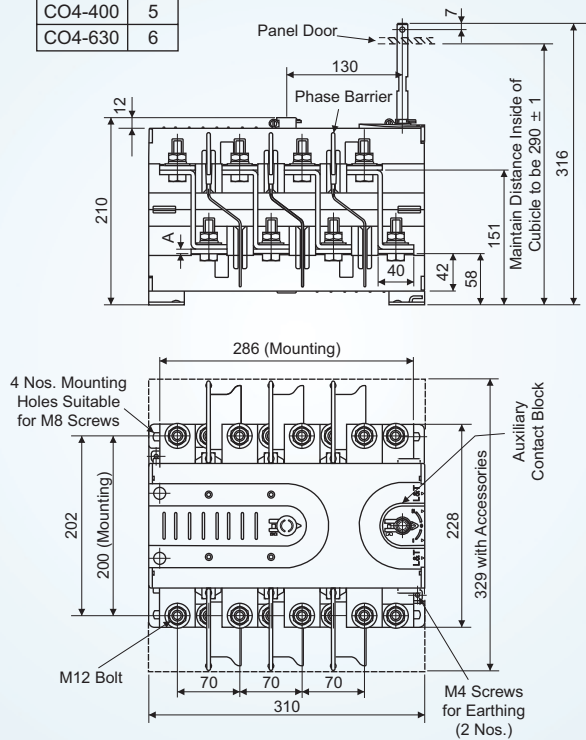

In SS Enclosure

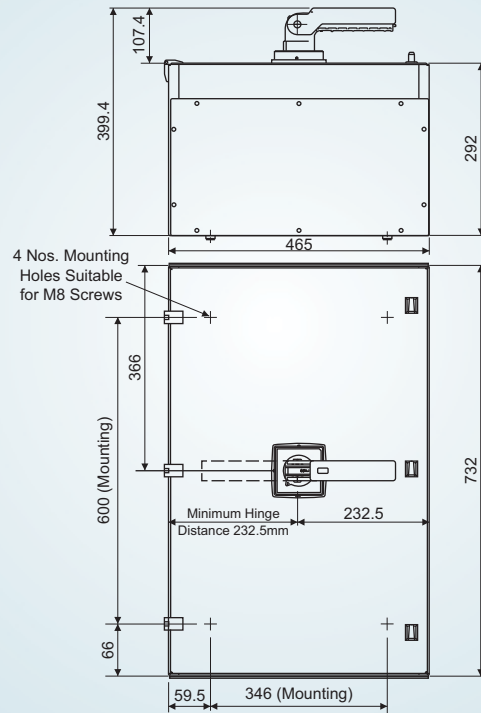

For DIN Type Fuses

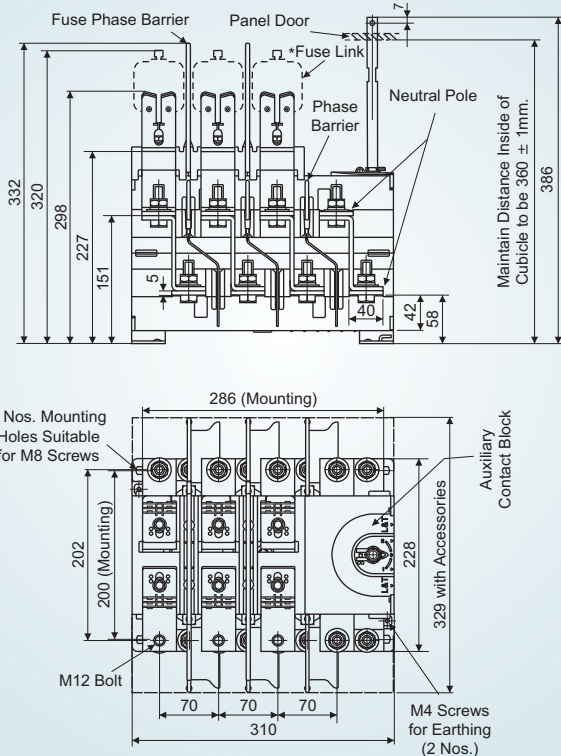

For BS Type Fuses

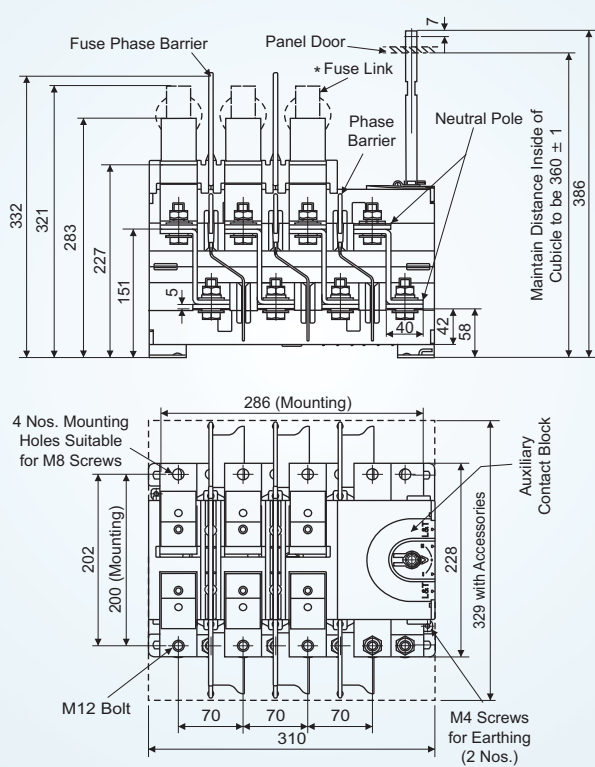

Overall Dimensions CO5 - 630 / 800 / 1000

Open Execution

Rating	A
CO5-630	6
CO5-800	8
CO5-1000	8

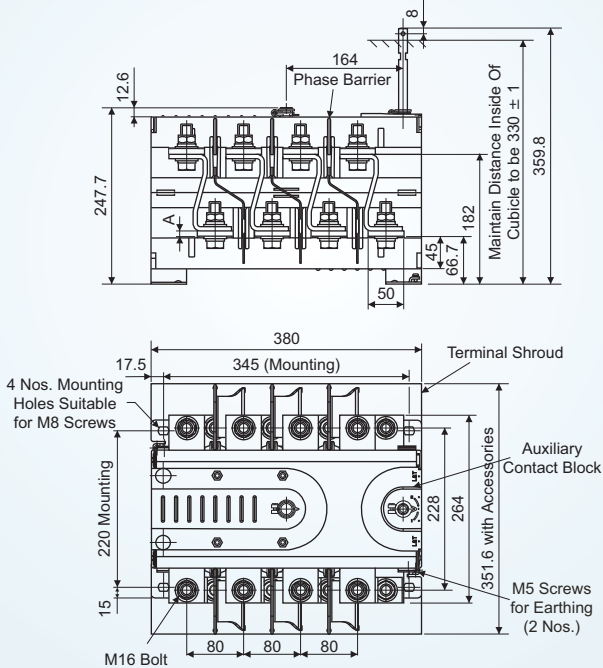

In SS Enclosure

Rating	Cat. No.
CO5-630	CO56300OS00
CO5-800	CO58000OS00
CO5-1000	CO51000OS00

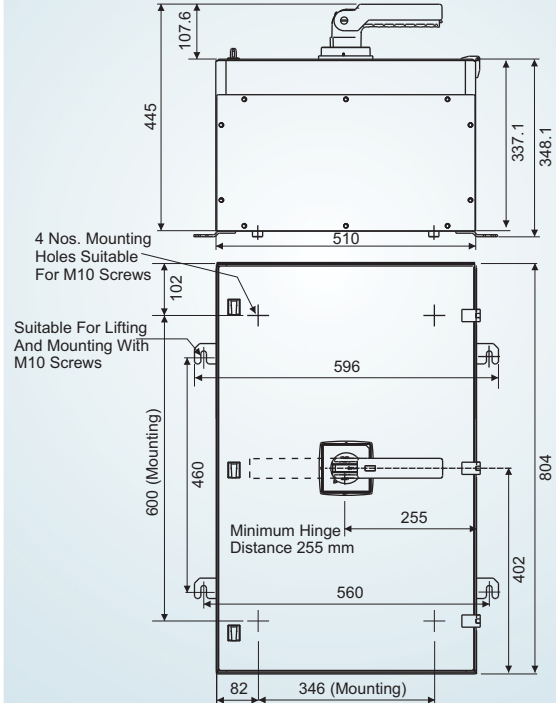

For DIN Type Fuses*

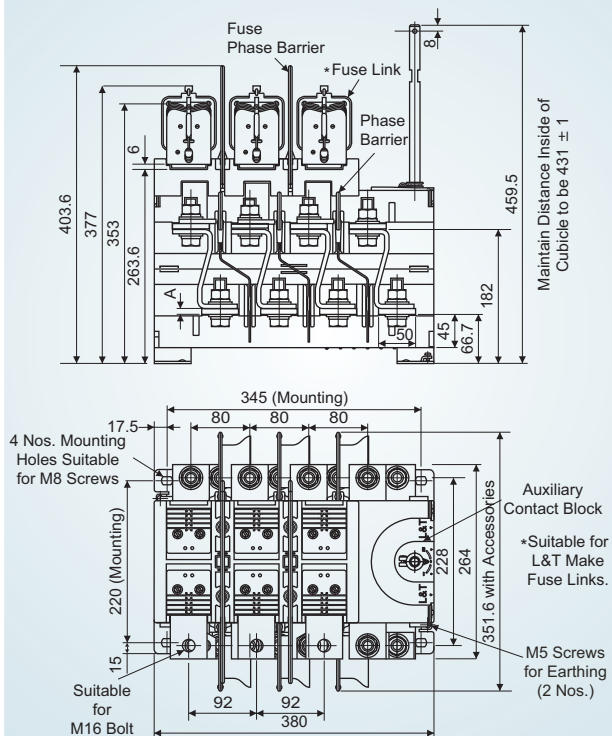

For BS Type Fuses*

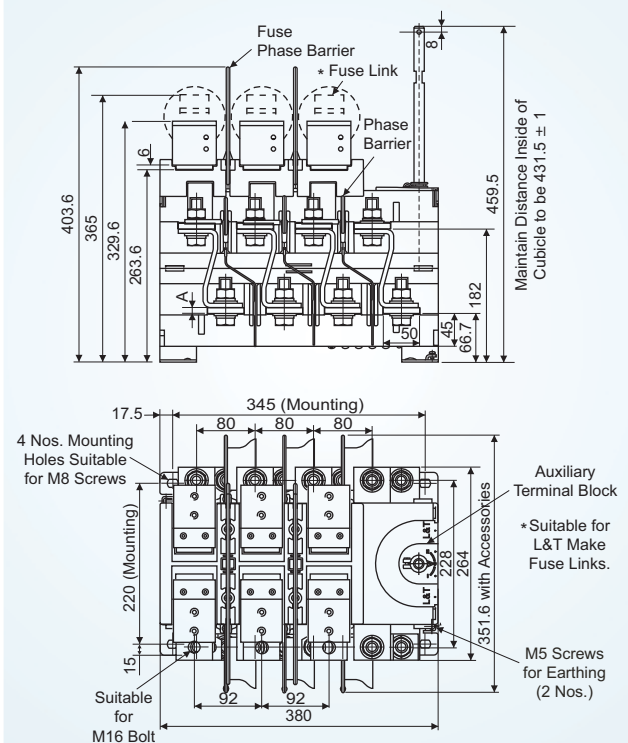

Electrical Standard Products (ESP) Branch Offices:

REGISTERED OFFICE AND HEAD OFFICE

L&T House, Ballard Estate
P. O. Box 278
Mumbai 400 001
Tel: 022-67525656
Fax: 022-67525858
Website: www.Larsentoubro.com

ELECTRICAL STANDARD PRODUCTS (ESP)

501, Sakar Complex I
Opp. Gandhigram Rly. Station
Ashram Road
Ahmedabad 380 009
Tel: 079-66304006-11
Fax: 079-66304025
e-mail: esp-ahm@LNTEBG.com

38, Cubbon Road, P. O. Box 5098
Bangalore 560 001
Tel: 080-25020100 / 25020324
Fax: 080-25580525
e-mail: esp-blr@LNTEBG.com

131/1, Zone II
Maharana Pratap Nagar
Bhopal 462 011
Tel: 0755-4098721 / 7 / 8 / 9
Fax: 0755-2769264
e-mail: esp-bho@LNTEBG.com

Plot No. 559, Annapurna Complex
Lewis Road
Bhubaneswar 751 014
Tel: 0674-6451342, 2436696
Fax: 0674-2537309
e-mail: esp-bbi@LNTEBG.com

SCO 32, Sector 26-D
Madhya Marg, P. O. Box 14
Chandigarh 160 026
Tel: 0172-4646840, 4646853
Fax: 0172-4646802
e-mail: esp-chd@LNTEBG.com

L&T Construction Campus
TC-1 Building, II Floor
Mount-Poonamallee Road
Manapakkam
Chennai 600 089
Tel: 044-2270 6800
Fax: 044-22706940
e-mail: esp-maa1@LNTEBG.com

67, Appuswamy Road
Post Bag 7156
Opp. Nirmala College
Coimbatore 641 045
Tel: 0422-2588120 / 1 / 5
Fax: 0422-2588148
e-mail: esp-cbe@LNTEBG.com

L&T House, Group MIG-5
Padmanabhpur
Durg 491 001
Tel: 0788-2213833 / 14 / 21 / 29
Fax: 0788-2213820
e-mail: esp-durg@LNTEBG.com

Khairasol, Degaul Avenue
Durgapur 713 212
Tel: 2559848, 2559849, 2559844
Fax: 0343-2553614
e-mail: esp-dgp@LNTEBG.com

Milanpur Road, Bamuni Maidan
Guwahati 781 021
Tel: 0361-2550562 / 65
Fax: 0361-2551308
e-mail: hazrasudipto@LNTEBG.com

II Floor, Vasantha Chambers
5-10-173, Fateh Maidan Road
Hyderabad 500 004
Tel: 040-67015052
Fax: 040-23296468
e-mail: esp-hyd@LNTEBG.com

Monarch Building, 1st Floor
D-236 & 237, Amrapali Road
Vaishali Nagar
Jaipur 302 021
Tel: 0141-4385914 / 18
Fax: 0141-4385925
e-mail: esp-jai@LNTEBG.com

Akashdeep Plaza, 2nd Floor
P. O. Golmuri
Jamshedpur 831 003
Jharkhand
Tel: 0657-2312205 / 38
Fax: 0657-2341250
e-mail: esp-jam@LNTEBG.com

Skybright Bldg; M. G. Road
Ravipuram Junction, Ernakulam
Kochi 682 016
Tel: 0484-4409420 / 4 / 5 / 7
Fax: 0484-4409426
e-mail: esp-cok@LNTEBG.com

3-B, Shakespeare Sarani
Kolkata 700 071
Tel: 033-44002572 / 3 / 4
Fax: 033-22821025 / 7587
e-mail: esp-ccu@LNTEBG.com

A28, Indira Nagar, Faizabad Road
Lucknow 226 016
Tel: 0522-2312904 / 5 / 6
Fax: 0522-2311671
e-mail: esp-Lko@LNTEBG.com

No: 73, Karpaga Nagar, 8th Street
K. Pudur
Madurai 625 007
Tel: 0452-2537404, 2521068
Fax: 0452-2537552
e-mail: esp-mdu@LNTEBG.com

EBG North Wing Office-Level 2
Gate 7, Powai Campus
Mumbai 400 072
Tel: 022-67052874 / 2737 / 1156
Fax: 022-67051112
e-mail: esp-bom@LNTEBG.com

12, Shivaji Nagar
North Ambazari Road
Nagpur 440 010
Tel: 0712-2260012 / 3
Fax: 0712-2260020 / 30
e-mail: esp-nag@LNTEBG.com

32, Shivaji Marg
P. O. Box 6223
New Delhi 110 015
Tel: 011-41419514 / 5 / 6
Fax: 011-41419600
e-mail: esp-del@LNTEBG.com

L&T House
P. O. Box 119
191/1, Dhole Patil Road
Pune 411 001
Tel: 020-26135048 / 26164048
Fax: 020-26124910, 26135048
e-mail: esp-pnq@LNTEBG.com

3rd Floor
Vishwakarma Chambers
Majura Gate, Ring Road
Surat 395 002
Tel: 0261-2473726
Fax: 0261-2477078
e-mail: esp-sur@LNTEBG.com

Radhadaya Complex
Old Padra Road
Near Charotar Society
Vadodara 390 007
Tel: 0265-6613610 / 1 / 2
Fax: 0265-2336184
e-mail: esp-bar@LNTEBG.com

48-8-16, Dwarakanagar
Visakhapatnam 530 016
Tel: 0891-6620411-2 / 3
Fax: 0891-6620416
e-mail: esp-viz@LNTEBG.com

Product improvement is a continuous process. For the latest information and special applications, please contact any of our offices listed here.



Larsen & Toubro Limited
Electrical Standard Products
Powai Campus, Mumbai 400 072
Customer Interaction Center (CIC)
BSNL / MTNL (toll free) : 1800 233 5858
Reliance (toll free) : 1800 200 5858
Tel : 022 6774 5858, Fax : 022 6774 5859
E-mail : cic@LNTEBG.com
Website : www.LNTEBG.com